

iomega®

zip®

250

Internal ATAPI Drive

Owner's Manual

- *Installation Guide*
- *User's Guide*
- *Troubleshooting*
- *How to Get Help*



IMPORTANT! Before installing the hardware for your Zip® Internal drive, insert the *Owner's Manual CD* and click the button that says "Watch Installation Video" to give you an overview of the installation process.

<http://www.iomega.com>



Table of Contents

Installation Guide

Getting Started	4
Identifying the IDE Configuration	6
Installing the Zip® drive as the Slave Device	11
Installing the Zip® drive as the only device on the secondary IDE channel	17
Installing the IomegaWare™ Software	23

User's Guide

Operating Your Zip® Drive	27
Zip® Tips	30
IomegaWare™ Software	31
Using Zip® Disks	33
Understanding IDE/ATAPI Connections	36

Troubleshooting

The green activity light does not turn on	38
The Zip® drive is not assigned a drive letter	38
Computer does not recognize a slave drive after installing the Zip® drive	39
Computer fails to boot correctly after installing the Zip® Internal drive	40
Computer won't boot in Windows NT unless a disk is in the Zip® drive	40
Data transfer problems	40
Installing the Zip® drive changes other drive letters	40
You want to change the drive letter for your Zip® drive	41
You can't change the drive letter assigned to Zip® drive	42
Zip® disk won't eject using Windows NT	42
Copy Machine problems in Windows 3.1	42
Using the Zip® drive in Windows 95/98 DOS Mode	43

How to Get Help

Iomega's Home Page	44
Automated Voice Technical Support	44
Automated FAX-Back Help	45
One-on-One Technical Support	45
Product Repair or Return	46
Warranty Information	46
Product Information	46
International Support Numbers	46

Welcome to Zip® Drive!

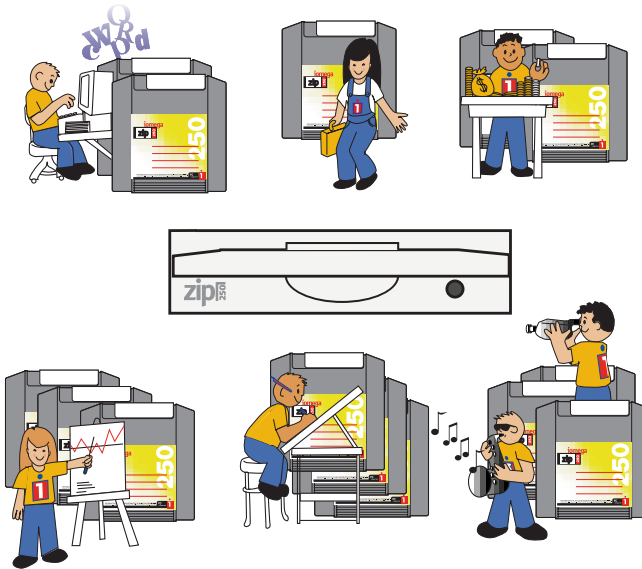

Zip® Internal ATAPI drive offers you everything a standard Zip® drive has with the ease of installing to an existing IDE channel on your computer! Here's how to get started using your new drive and software:

- 1 Install your Zip® Internal drive and IomegaWare™ software using the instructions in the **Installation Guide** (pages 4-26 of this manual).
- 2 Check the **User's Guide** (pages 27-37 of this manual) for information on using your Zip® drive and IomegaWare™ software.
- 3 Insert a Zip® disk and start using your new Zip drive to:

Expand your computer storage – 250MB or 100MB at a time...
Move your work to different locations and computers... **Back up** your hard disk quickly and easily*... **Create** a multimedia library...
Store large scanned or downloaded files... **Protect** sensitive information... **Organize** large amounts of information... **Take** work home or on the road... **Store** and run all your games... **Stretch** the limits of your creativity!

■ ***IMPORTANT!** Two or more blank 250MB Zip® disks are required to utilize the full backup and recovery capabilities of the software package included with your drive. For maximum reliability, use only Genuine 250MB and 100MB Zip® disks. ■

Getting Started

■ **IMPORTANT!** The Zip Internal drive uses the computer's onboard IDE/ATA interface. See the **User's Guide** section **Understanding IDE Connections** on pages 36 and 37 of this guide for important information. ■

1 Check system requirements.

- Pentium 100 MHz or higher IBM-compatible computer
- Empty 3½" or 5¼ " drive bay with front panel access
- Embedded IDE interface or IDE controller card
- Windows NT®, Windows® 95/98, or Windows 3.1
- Iomega software (included with the Zip® Internal drive)

■ **NOTE:** The Zip® Internal drive meets the latest ATAPI specifications; however, some computers with early ATAPI support do not meet these specifications and may not work correctly with removable ATAPI drives like the Zip Internal drive. If the computer fails to boot correctly or hangs while booting after the Zip Internal drive is installed, refer to page 40 in the **Troubleshooting** section of this guide. ■

2 Unpack the Zip® Internal ATAPI drive.

■ **CAUTION** Before handling the Zip® Internal drive, touch a grounded metal object (like an unpainted metal screw on the back of your computer) to discharge any buildup of personal static electricity. ■

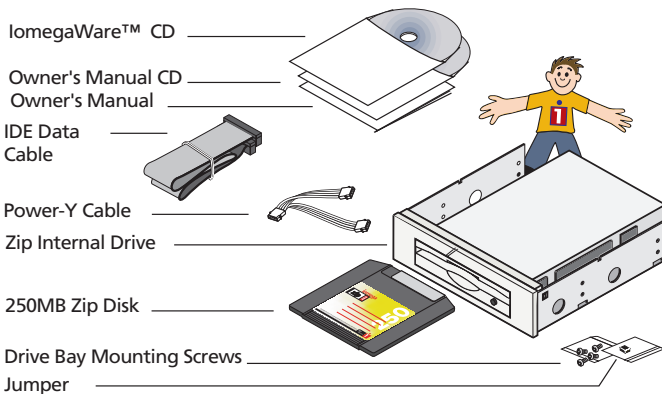

■ **IMPORTANT!** The jumper that shipped with your Zip drive is not always needed for proper installation. ■

3 Watch the instructional video.

Before installing the hardware for your Zip® Internal drive, insert the Owner's Manual CD and click the button that says "Watch Installation Video" to give you an overview of the installation process.

4 Write down the serial number of your Zip® Internal ATAPI drive for future reference.

You will need the serial number of your Zip Internal drive for registration purposes or if you need to call technical support. The serial number is located on the label on the top of your Zip drive. Write it down and keep it with your documentation.

5 DISCONNECT the computer power cord and remove the cover. *(Refer to your computer manual for more complete instructions.)*

Some computers require removing the computer's face plate as well as the cover to access the drive bays.

WARNING Always disconnect computer electrical power before beginning a computer hardware change. ■

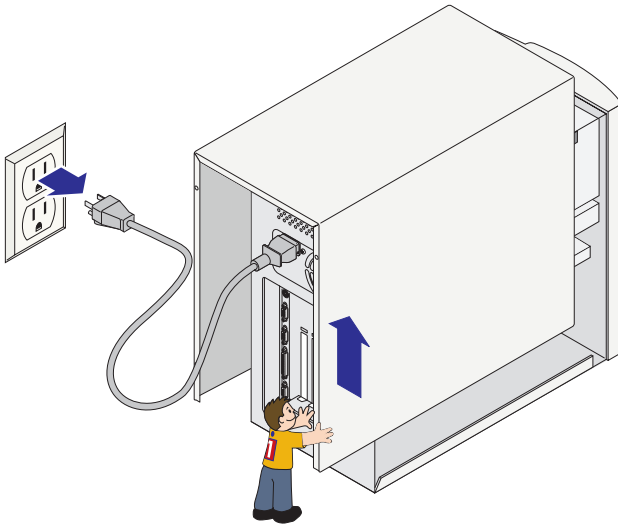

■ **IMPORTANT!** Be aware that computers are arranged differently and that your computer may not look like the illustrations shown. ■

Identifying the computer's IDE configuration

☞ IDE/ATAPI devices can be connected to your computer in different configurations. The following illustrations are examples of ways the IDE/ATAPI devices may be connected to your computer. If you are familiar with IDE connections, you can use these to quickly find your configuration and go to the appropriate hardware installation section. If you are not able to recognize your computer's configuration from these illustrations, detailed instructions starting on the following page will help you do this. Omega suggests that you install your Zip® drive on the secondary IDE channel.

☞ If your hard drive and CD drive are connected to different IDE channels, see [pages 11-16](#) for instructions on installing your Zip drive.

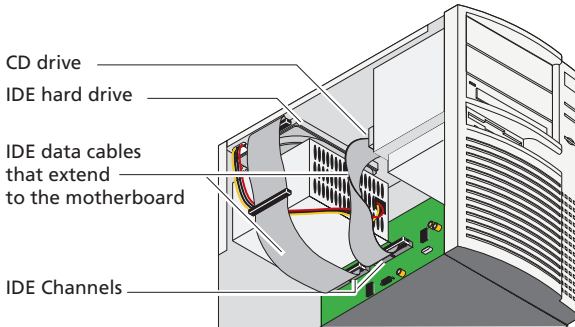

☞ If your hard drive and CD drive are connected to the same IDE channel, see [pages 17-22](#) for instructions on installing your Zip drive.

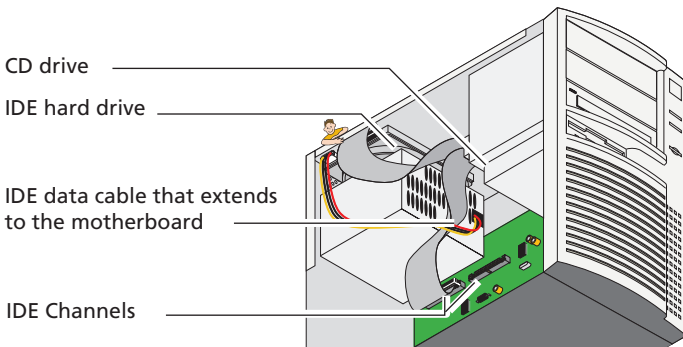

1 Follow these instructions if you were unable to identify your computer's IDE configuration from the illustrations on the previous page:

1a Locate the IDE channels using the CD drive

From the back of the CD drive in your computer, follow the flat, wide cable to where it connects to the large main board, or motherboard. The area where it connects is called the IDE channel. If the cable leads to the motherboard, go to step 2 on the next page.

If you find that the CD drive is connected to a card that is attached to the motherboard (probably the sound card), go to the next step and follow the instructions to locate the IDE channels using the computer's hard drive.

1b Locate the IDE channels using the computer's hard drive

If you don't have a CD drive on your computer, you will need to use the hard drive to locate the IDE channels. There are many locations within your computer where your hard drive might be found. Here are a few of the locations to help you get started.

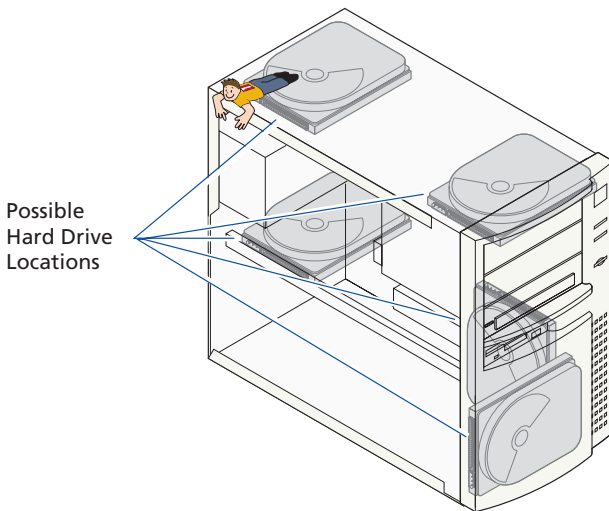

Locate your computer's hard drive and the flat, wide cable attached to it. Follow this cable to where it connects to the large main board or motherboard. This connection is called the IDE channel.

■ **IMPORTANT!** If you are unable to locate the hard drive and IDE channels from the illustrations shown, (you will need to refer to your computer's manual for additional help). ■

1c Possible IDE channel locations

There are usually two IDE channels, called the primary and secondary IDE channel, which are either side-by-side or end-to-end as shown in the illustrations below. Look for “pri IDE” and “sec IDE,” written on the motherboard to identify which channel is the primary and which is the secondary. The hard drive is usually connected to the primary IDE channel.

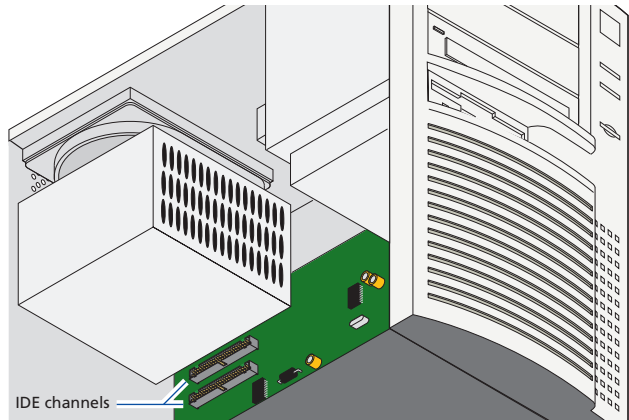
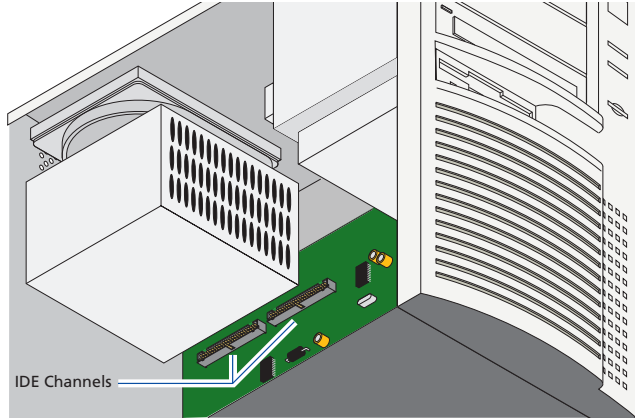

2 Determining your computer's configuration

Once you have located the IDE channels, determine the configuration of the IDE/ATAPI devices that are connected to your computer. Steps 2a through 2c show some possible ways that your computer might be configured.

2a If the hard drive is the only IDE device connected...

The hard drive is usually connected to the primary IDE channel. If the hard drive is the only IDE device connected, the secondary IDE channel will be unused, as shown in the illustration below. With this configuration, connect the Zip drive to the secondary IDE channel as the master device. For instructions see the section entitled **Installing the Zip drive as the only device on the secondary IDE channel** on page 17 of this manual.

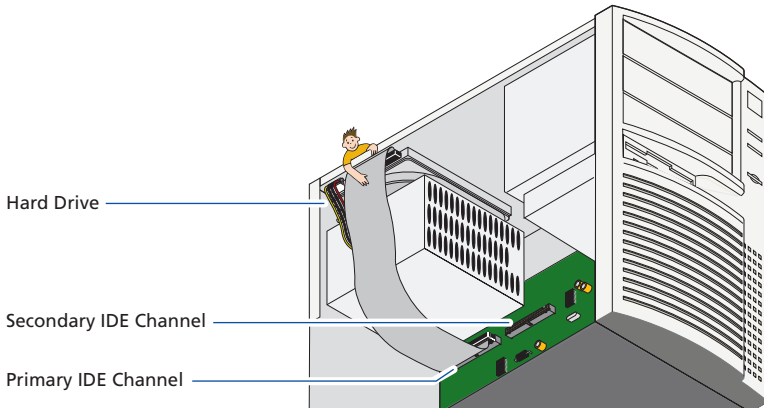

Continued on next page ...

2b If the CD drive and hard drive are on different IDE channels...

Follow the IDE interface cable to find out if the CD drive is the only device connected to the secondary IDE channel. If it is, see **Installing the Zip Drive as the Slave Device** starting on page 11 of this manual for instructions on installing your Zip® drive.

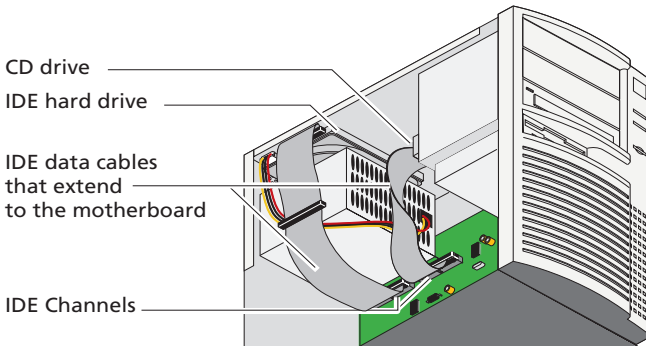

2c If the CD drive and hard drive are on the same IDE channel...

If the CD drive and the hard drive are both connected to the primary IDE channel, the secondary IDE channel should be unused, as shown in the following illustration. If your system has this configuration, see the section entitled **Installing the Zip® drive as the only device on the secondary IDE channel** starting on page 17 of this manual for instructions on installing your Zip® drive.

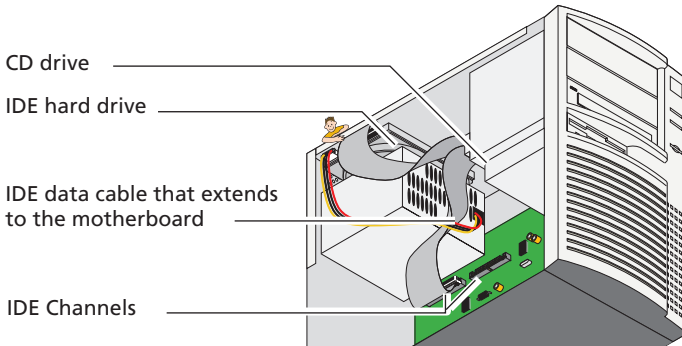

Installing the Zip® drive as the slave, or second device

■ **IMPORTANT!** The Zip® Internal drive uses the computer's onboard IDE/ATA interface. If you are not familiar with how devices connect to the IDE interface, please see **Understanding IDE Connections** section on pages 36 and 37. ■

■ **NOTE:** Iomega recommends that you connect your Zip® drive to the secondary IDE channel and not on the same channel as your hard drive. ■

1 Check the jumper setting on the Zip® drive.

The Zip® Internal drive is set as the factory default to the “slave” configuration indicating that another drive connected to the same IDE cable will be the “master”. This is the way the Zip® drive should be set to connect it to the secondary IDE channel with your CD drive. Verify that there is no jumper on the back of the Zip® drive as shown in the illustration below. The jumper is a small plastic piece that surrounds two of the pins.

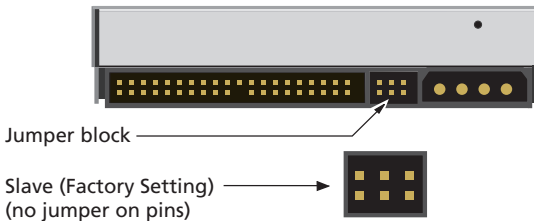

2 Locate a vacant drive bay and remove the panel cover.

The Zip® Internal drive is ready to install in a 5 1/4” drive bay. The mounting bracket must be removed for installation in a 3 1/2” drive bay.

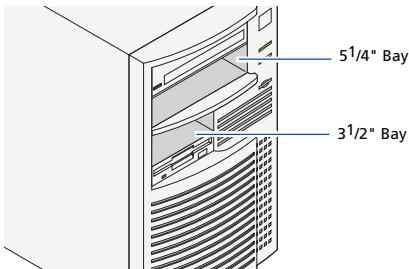

2a 3 1/2" drive bays ONLY.

To install your Zip® drive in a 3 1/2" drive bay, remove the mounting screws as illustrated and slide the drive out of the sled.

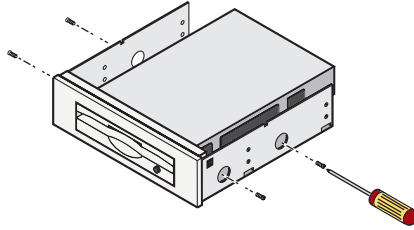

3 Check mounting requirements. Your drive bay may require side rails.

■ **HINT:** Check other drives in the system (such as a CD drive) to see if they use mounting rails. If so, you may need similar mounting rails for the Zip® Internal drive. If the computer does not include extra mounting rails, contact your computer dealer to obtain them. ■

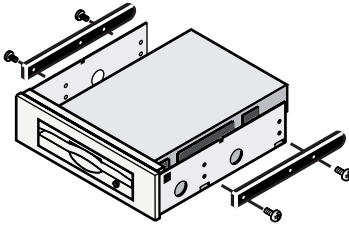

5 1/4" Bay

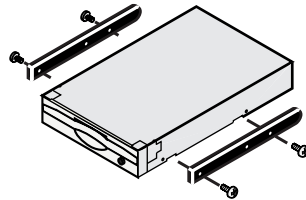

3 1/2" Bay

4 Slide the Zip® drive into the drive bay.

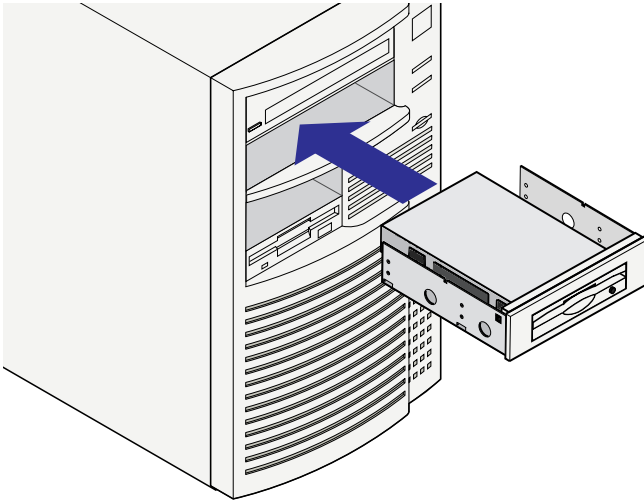

■ **NOTE:** If it makes it easier to connect cables on your computer, you can secure the Zip® drive in the drive bay now. (See step 9 for instructions on securing the drive.) ■

5 Remove the IDE Interface cable that is currently connected to your CD drive.

Find the flat, wide cable connected to the back of the CD drive. Note the side of the cable with the red stripe or PIN 1 indicator and disconnect the cable from the motherboard and the CD drive and set it aside.

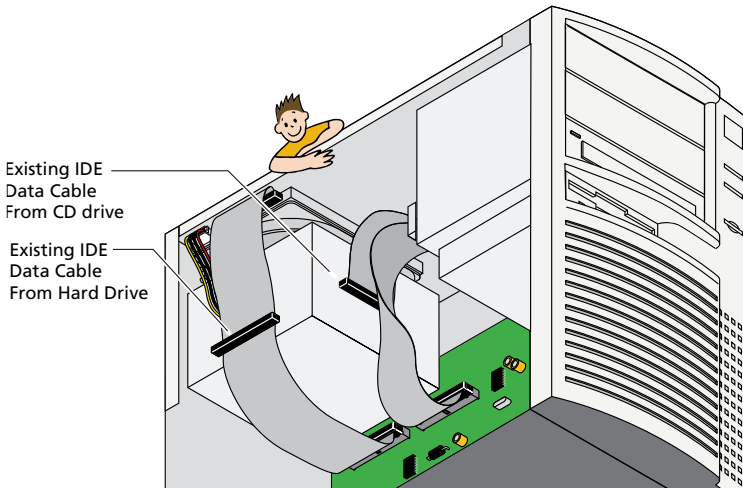

6 Verify that the jumper on your CD drive is set to "Master."

In order for the CD drive and Zip® drive to work together properly, ensure that the jumper on the CD drive is set to the "master" setting. A chart indicating the jumper setting should be located on the CD drive. If you are unsure of the setting or how to change it, refer to the documentation that came with your CD drive or computer.

7 Connect the CD drive and the Zip® Internal drive to the motherboard.

Using the 40-pin IDE interface cable that is provided, connect the long end, or the end furthest from the middle connector on the cable, to the secondary IDE channel. Connect the middle connector to the CD drive and then connect the other end of the cable to the Zip® Internal drive.

CAUTION Make sure PIN 1 on the cable connects to PIN 1 on the Zip® Internal drive, the CD drive and the motherboard. All IDE interface cable connections must maintain correct PIN 1 orientation in order for the Zip® drive to be recognized by the system. ■

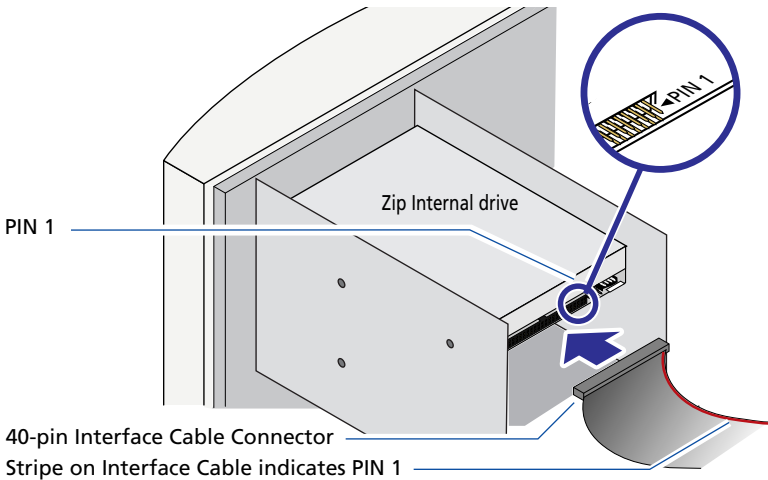

The IDE interface cable can be connected from the secondary IDE channel to the CD drive and then to the Zip® drive, or it can be connected from the secondary IDE channel to the Zip drive and then to the CD drive. For information on possible IDE/ATAPI drive configurations for your computer, see [Understanding IDE Connections](#) on pages 36 and 37.

8 Connect an internal computer power supply cable to the Zip® drive.

■ **NOTE:** If the computer does not have a spare power supply cable, use the power Y-cable provided. Disconnect the power from the CD drive or another device (do not disconnect the power to the hard drive) and connect the power Y-cable. Connect the two extensions of the power Y-cable to both the CD drive or other device and to the Zip® Internal drive. ■

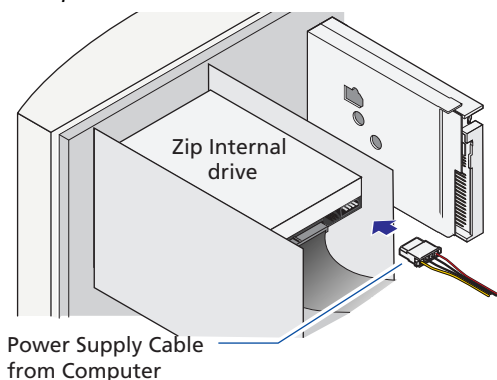

CAUTION Make sure the power supply cable is securely connected to the Zip® drive. ■

9 Secure drive in drive bay.

Align the front of the Zip® drive with other drives installed in the computer. If there is not clear access to the drive bay mounting holes, refer to your computer manual for additional instructions. Note that if the drive is held in place securely by rails, you will not need to use the mounting screws.

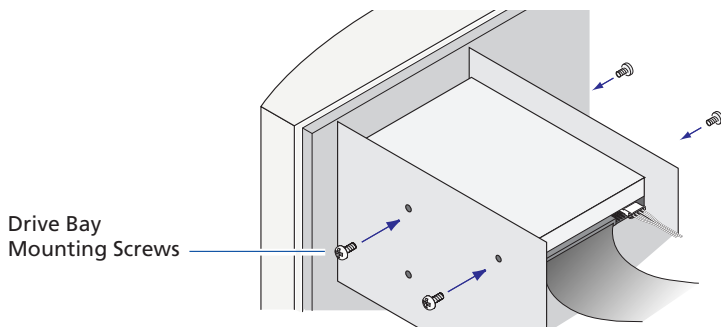

CAUTION Mounting screws must not extend into the Zip® Internal drive farther than 4.0 mm (about 0.16 inch). Mounting screws that are too long could damage the drive. ■

10 Check the following items before replacing the computer cover:

- ✓ PIN 1 on the IDE interface cable matches the PIN 1 connector on your Zip® Internal drive.
- ✓ The IDE interface cable is securely connected to all pins on your Zip® drive.
- ✓ An internal power supply cable from the computer has been connected to your Zip® drive.
- ✓ Your Zip® drive has been securely mounted to your computer.
- ✓ Make sure the IDE interface cable is still connected properly at the hard drive or CD drive and the motherboard connections.

11 Check all connections, arrange the cables to fit under the cover, and replace the computer cover.

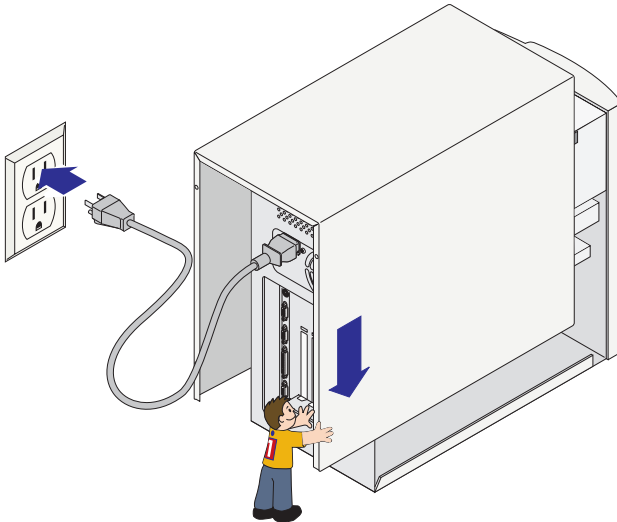

12 Reconnect power cord, turn ON power switch, and wait for the operating system to load.

13 Go to page 23 of this manual for instructions on installing the Zip® ATAPI driver and the lomegaWare™ software.

Installing the Zip® drive as the only device on the secondary IDE channel

■ **IMPORTANT!** The Zip® Internal drive uses the computer's onboard IDE/ATA interface. If you are not familiar with how devices connect to the IDE interface, please see **Understanding IDE Connections** on pages 36 and 37. ■

1 Change the jumper setting to "Master".

The Zip Internal drive is set to the slave configuration as the factory default at shipping. In order to connect the Zip Internal drive as the only device on the secondary IDE channel, you will need to change the jumper setting on the drive. The jumper is a small plastic piece that surrounds two pins. Use the jumper provided and set it on the back of the Zip drive as shown in the illustration below.

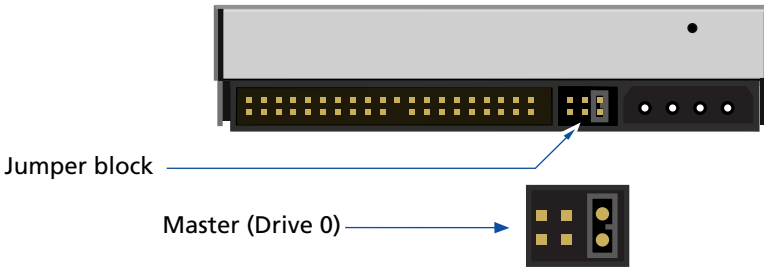

2 Locate a vacant 3 1/2" or 5 1/4" drive bay.

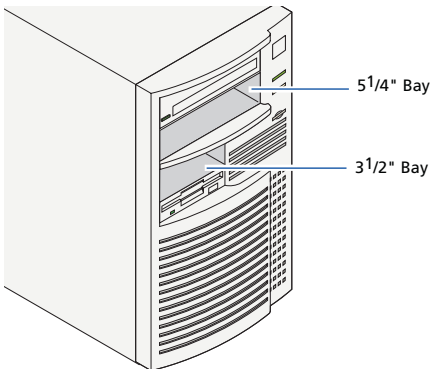

2a 3 1/2" drive bays ONLY.

To install your Zip® drive in a 3 1/2" drive bay, remove the mounting screws as illustrated and slide the drive out of the sled.

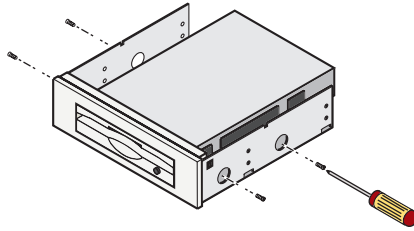

3 Check mounting requirements. Your drive bay may require side rails.

■ **HINT:** Check other drives in the system (such as a CD drive) to see if they use mounting rails. If so, you may need similar mounting rails for the Zip® Internal drive. If the computer does not include extra mounting rails, contact your computer dealer to obtain the them. ■

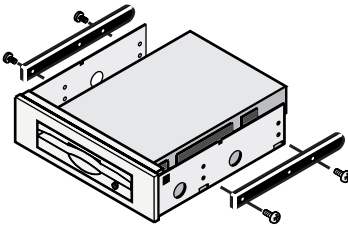

5 1/4" Bay

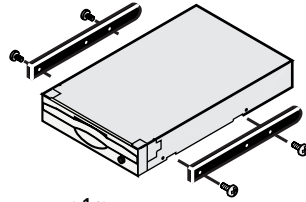

3 1/2" Bay

4 Slide the Zip® drive into the drive bay.

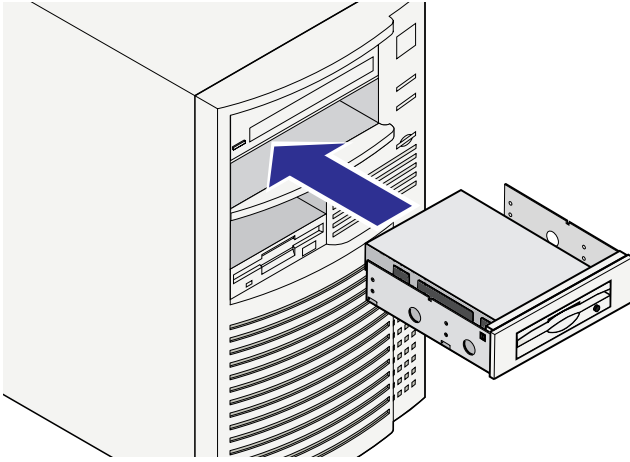

■ **NOTE:** If it makes it easier to connect cables on your computer, you can secure the Zip® drive in the drive bay now. (See step 9 for instructions on securing the drive.) ■

5 Locate the data cable that comes packaged with the Zip® drive. Find the colored stripe or print on one side of the data cable showing PIN 1.

Stripe or printing shows the PIN 1 side of the data cable.

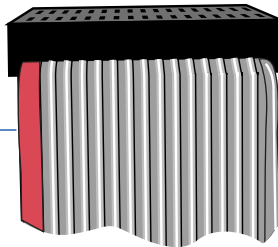

Locate the PIN 1 connection on the IDE channel. PIN 1 on your computer's IDE channels can be indicated by any of the following marks. If you have a keyed receptacle, you should only be able to connect the cable one way.

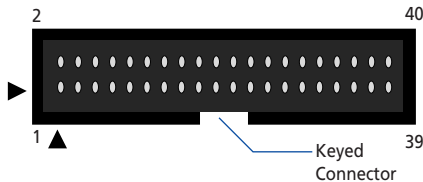

6 Connect the data cable to the secondary IDE channel on the motherboard. *(Be sure PIN 1 on the cable is connected to PIN 1 on the motherboard.)*

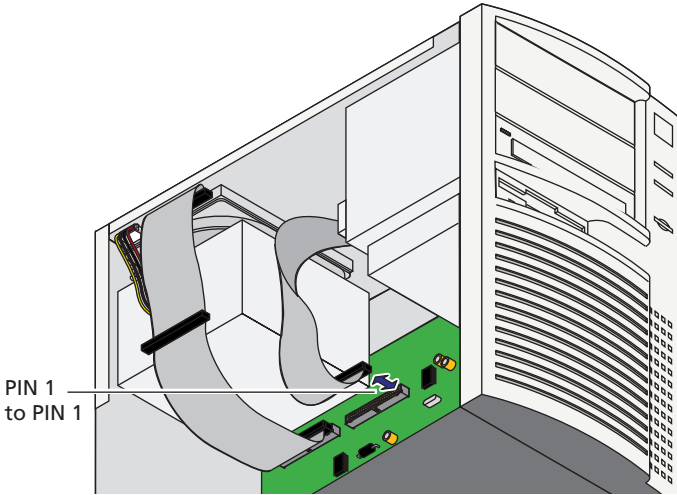

7 Connect the other end of the data cable to the Zip® drive.

CAUTION Make sure PIN 1 on the cable connects to PIN 1 on the Zip® Internal drive. All IDE interface cable connections must maintain correct PIN 1 orientation in order for the Zip® drive to be recognized by the system. ■

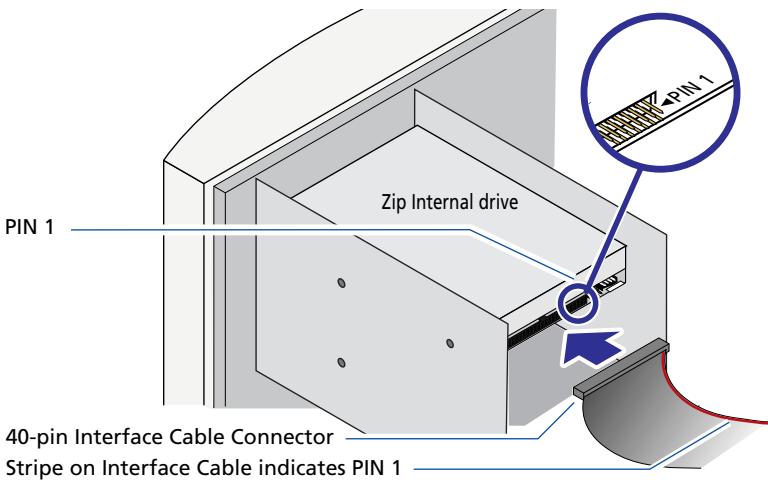

8 Connect an internal computer power supply cable to your Zip® drive.

■ **NOTE:** If the computer does not have a spare power supply cable, use the power Y-cable provided. Disconnect the power from the CD drive or another device (do not disconnect the power to the hard drive) and connect the power Y-cable. Connect the two extensions of the power Y-cable to both the CD drive or other device and to the Zip® Internal drive. ■

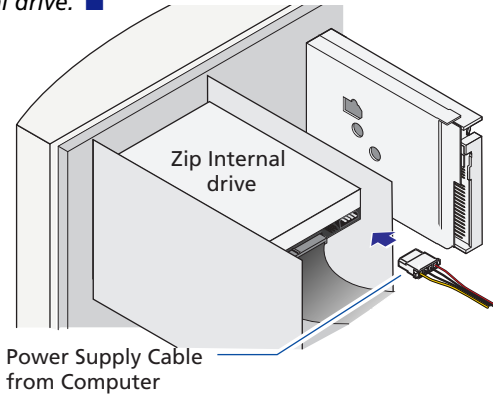

CAUTION Make sure the power supply cable is securely connected to the Zip® drive. ■

9 Secure drive in drive bay.

Align the front of the Zip® drive with other drives installed in the computer. If there is not a clear access to the drive bay mounting holes, refer to your computer manual for additional instructions. Note that if the drive is held in place securely by rails, you will not need to use the mounting screws.

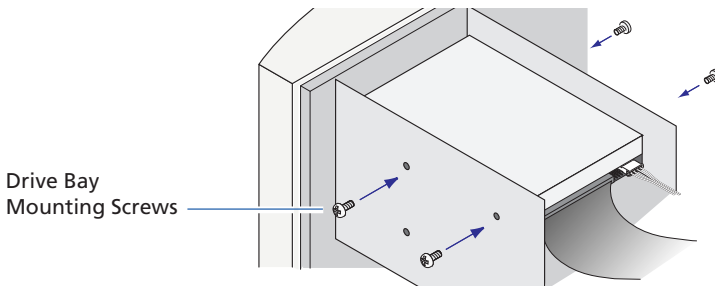

CAUTION Mounting screws must not extend into the Zip® Internal drive farther than 4.0 mm (about 0.16 inch). Mounting screws that are too long could damage the drive. ■

10 Check the following items before replacing the computer cover:

- ✓ PIN 1 on the IDE interface cable matches the PIN 1 connector on your Zip® Internal drive and the motherboard.
- ✓ The IDE interface cable is securely connected to all pins on your Zip® drive.
- ✓ An internal power supply cable from the computer has been connected to your Zip® drive.
- ✓ Your Zip® drive has been securely mounted to your computer.

11 Check all connections, arrange the cables to fit under the cover, and replace the computer cover.

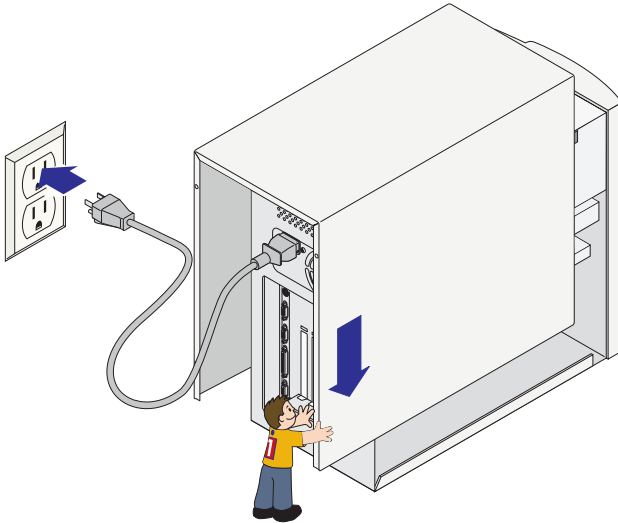

12 Reconnect power cord, turn ON power switch, and wait for the operating system to load.

13 Turn to the next page for instructions on installing the Zip® ATAPI driver and the omegaWare™ software.

Installing the IomegaWare™ Software

- 1 Insert the IomegaWare™ CD into the computer's CD drive.

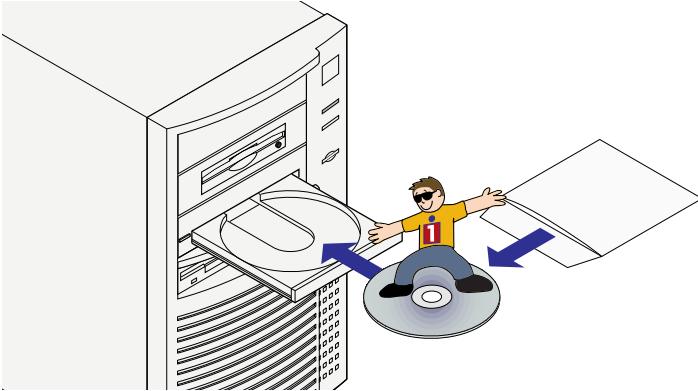

■ **No CD Drive?** If you want to install the Zip® Internal drive on a computer that does not have a CD drive, you can download Iomega software from the Internet. You can also create an install floppy diskette for installing only the critical software drivers. Refer to **How to Install Without a CD drive** on page 25 for additional information. ■

- 2 If the Iomega software setup program does not start automatically, follow these steps:

- a) Open *My Computer*, *Windows Explorer*, or *File Manager*.
- b) Double click the CD drive letter (usually D:, E:, or F:).
- c) Double click **Setup.exe**.

- 3 Follow the screen instructions to install the software.

Additional instructions for your system...

Windows 95/98 Users

Your Zip[®] drive and IomegaWare[™] software should now be ready to use. Open *My Computer* to see if you have an icon for your Zip drive.

Windows NT Users

The Iomega installation software will try to install and update the necessary drivers on your system. If the Zip[®] drive does not appear on your system, or appears as the B: drive, after the Iomega software installation is complete and your system has rebooted, you will need to manually install the driver using the procedure described for Windows NT 3.51. Windows NT 4.0 is automatically updated.

■ **IMPORTANT!** *You must have administrator privileges for your local computer in order to install the Iomega software or the Zip[®] ATAPI software driver under Windows NT.* ■

Installing the Iomega Zip[®] ATAPI driver under Windows NT 3.51

1. If you have not already done so, install Iomega software from the IomegaWare[™] CD using the **setup.exe** program.
2. From the Windows NT Main program group, double click on the Windows NT Setup icon.
3. From the Setup window, choose the Options pull-down menu and select "Add/Remove SCSI adapters."
■ **NOTE:** *Windows NT installs drives or adapters that use the IDE interface as SCSI adapters.* ■
4. When the list of adapters appears, click "Add," then click "OK" in the message box.
5. Click the down arrow next to the window for "Select SCSI Adapter Option" to open the adapter list.
6. Scroll down to the bottom of the adapter list box and click on "Other."
7. Make sure the IomegaWare CD is inserted into the computer's CD drive.
8. Select the drive letter for the CD drive and open the folder for the language you want to use.
9. Open the WNTStuff folder, then open the IDE folder.
10. Click "OK." When the list of Iomega adapters appears, select the Iomega Zip ATAPI/IDE driver and click "OK."

11. Click the “Install” button. Windows NT will copy the driver file and add the Iomega Zip® driver to the list of installed adapters found by the system.
12. Click the “Close” button and exit Windows NT Setup.
13. Click “OK” at the message box and reboot the system.
14. Your Zip® drive and Iomega software should now be ready to use.

If your drive letters change after installing the Zip® Internal drive:

Refer to the **Troubleshooting** section starting on page 38 for instructions on how to assign a specific drive letter for your Zip® drive.

How to Install Without a CD Drive

If you need to install or use your Zip® drive on a computer that does not have a CD drive, you can download Iomega software from the Internet or install the necessary driver software from a floppy diskette.

Download Software from the Iomega Web Site

Visit Iomega’s web site for the latest version of Iomega software. All components of the IomegaWare™ software package can be downloaded.

1. Visit the Iomega web site at <http://www.iomega.com>.
2. Click on **Software Download** to find the Iomega software package for your system.

Create Install Floppy Diskettes

If you have access to a computer that has a CD drive, you can create floppy diskettes for installing the necessary driver software:

■ **NOTE:** *The floppy install diskette can only be used on a PC. The install diskette includes only the driver software required to provide access to the Zip® drive, not the complete Iomega software package. You can download all components of the software package from Iomega’s web site.* ■

1. Insert a blank floppy diskette into the computer’s floppy drive.
2. Insert the IomegaWare™ CD into the CD drive. If the Setup program starts automatically, cancel by clicking **Exit Setup**.
3. Open *My Computer* or *Windows Explorer*, right click on the icon for the IomegaWare CD, and select **Explore** from the shortcut menu.

4. Double click the **Diskette** icon, and follow the screen instructions.
5. To install software drivers for your Zip[®] drive, run **setup.exe** from the install diskette you created.



Congratulations! When the software installation is complete, your Zip[®] drive will be ready to use.

Your Zip[®] drive will have its own drive letter just like any other drive on your computer. Store and copy files to and from the Zip[®] drive like you do on other drives. For additional information on using the Zip[®] drive and IomegaWare[™] software, refer to the **User's Guide** starting on the next page.

Operating Your Zip® Drive

To use the Zip® drive, insert a 250MB* Zip disk, then select the drive letter assigned to the Zip drive in *My Computer* (Windows 95/98; Windows NT 4.0) or *File Manager* (Windows NT 3.51; Windows 3.1). You can store and copy files to and from the Zip® drive using the same methods you use for other drives on your system. (If you need instructions on how to copy files, refer to the help file for your operating system.)

*250MB or 100MB capacity where 1MB = 1 million bytes. The capacity reported by your operating system may vary. Use 250MB Zip disks for maximum performance.

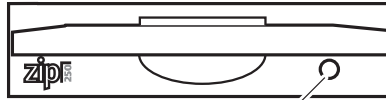

Disk Eject Button / Green Activity Light
(Flashes when drive is transferring data or a disk is inserted or ejected)

Inserting Zip® Disks

Always turn on power to the computer before inserting a Zip® disk. When you insert a Zip® disk, the drive activity light will flash momentarily and go out. (If the light continues to blink slowly, push the disk eject button to eject the Zip® disk, then reinsert it.)

IMPORTANT!
Insert Gently!

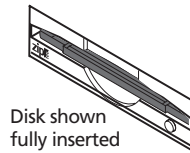

Disk shown fully inserted

CAUTION Never put anything into your Zip® drive except Zip disks with the genuine Zip 250 or Zip 100 symbol. Using disks that do not have the genuine Zip symbol may cause damage to your drive or loss of data. ■



Ejecting Zip® Disks

Windows 95/98 systems: Push the disk eject button or use the Iomega software eject command.

Windows NT systems: Use the Iomega software eject command.

Windows 3.1 systems: Push the disk eject button.

When your Zip® drive is not in use, remove the disk from the drive. Always remove the Zip® disk before moving your computer.

Disk Eject in Case of Power Loss

The computer must be powered on for normal disk insertion and removal. If you need to eject a Zip® disk during a power failure, access the rear of the Zip drive and push a straightened paper clip into the emergency eject hole which is located just above the power connector (see illustration below).

CAUTION *Disconnect power from the computer before using the emergency disk eject hole. Do not try to forcibly remove a Zip® disk from the drive. If the disk does not eject immediately, repeat the emergency disk eject procedure as described above. ■*

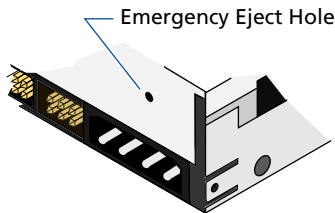

Drive Sleep

The Zip® Internal drive has an automatic sleep mode that spins down a Zip® disk after 15 minutes of inactivity. This feature minimizes power consumption when the Zip drive is not being accessed. The Zip disk automatically spins up again when the drive is accessed.

You can use the Iomega Tools program included with your drive to change the drive sleep setting. Refer to the Iomega Tools help file included in your software package for additional information.





■ **Windows 3.1 or Windows NT 3.51 users** - See the *Iomega Tools help file* included in your software package for instructions. ■

Compatibility with 100MB Zip® Disks

The 250MB Zip® drive features backward compatibility that allows you to read and write to 100MB Zip disks. However, because of the higher capacity of the 250MB Zip drive, performance when writing to a 100MB Zip disk is significantly reduced. This means that a large file that takes 10 seconds to write to a 250MB Zip disk could take about a minute-and-a-half to write to a 100MB Zip disk (using your 250MB Zip ATAPI drive to write both disks).

To maximize performance of your 250MB Zip® drive, you should use 250MB Zip disks whenever you want to store new information. If you have existing data on 100MB disks, you can transfer it to 250MB Zip disks using Copy Machine. (See the [Copying Zip Disks](#) on page 33.)

Here are some important things to know about using 250MB and 100MB Zip® disks and drives together:

-  If you write information to a 100MB Zip® disk using a 250MB Zip drive and later find that the disk cannot be read by a 100MB Zip drive, try reading the disk again in your 250MB Zip drive.
-  If the 250MB Zip® drive appears to hang when you are writing to a 100MB Zip® disk, you can verify that the drive is operating correctly by checking that the green activity light is blinking irregularly. (A slow, steady blink may indicate a problem with the drive. If there is a slow, steady blink, try pushing the disk eject button to eject the disk, then reinserting it.)
-  You can use the Short Format option if you need to format a 100MB Zip® disk in a 250MB Zip drive; the Long Format option is not supported for 100MB Zip disks in the 250MB Zip drive.
-  A 250MB Zip® disk cannot be used in a 100MB Zip drive; the 100MB Zip drive will automatically reject a 250MB disk.

Zip® Tips

Here are a few tips you'll want to keep in mind to care for your Zip® drive and disks!

- ⌚ Always turn on power to your computer before inserting a Zip® disk.

CAUTION *If a disk is inserted without the power on, and power is then applied, it could damage the drive. ■*

- ⌚ Never force a Zip® disk into or out of the drive.

- ⌚ Never use ordinary 3.5" diskettes or floppy head-cleaning disks in your Zip® drive. They will damage your drive. Only use 250MB or 100MB Zip disks with the Zip logo on them.

CAUTION *Never put anything into your Zip® drive except Zip disks with the genuine Zip 250 or Zip 100 symbol. Using disks that do not have the genuine Zip symbol may cause damage to your drive or loss of data. ■*



- ⌚ Avoid exposing Zip® disks to direct sunlight, high temperature, moisture, and magnetic fields (such as from monitors or speakers).

IomegaWare™ Software

The IomegaWare software package* includes tools and programs designed to help you take advantage of all the features of your Zip® drive. You can use Iomega software to format, copy, and protect your Zip disks, back up your hard drive, set options for your Zip drive, and more. The Iomega software package includes:



1-Step Backup/Restore

1-Step Backup easily backs up data files from your hard drive to Zip® disks. (1-Step Backup does not back up all of your operating system files or files that are in use.) When you need to restore a backup, double click the 1-Step Restore icon. For information on using 1-Step Backup/Restore, see **IomegaWare Quick Help** in the IomegaWare folder or click the Help button that is available when the program is running. 1-Step Backup/Restore is available for Windows 95/98 and Windows NT.



RecordIt™ Software

RecordIt software allows you to record audio tracks from a compact disc to a Zip® disk and take those recordings anywhere a Zip drive is available. The *Audio Mic In* feature allows you to record from a microphone, making it easy and convenient to record meetings or to dictate a memo. RecordIt software is available for Windows 95/98.

■ **IMPORTANT!** *RecordIt software is intended for non-infringing use only. Digital recording of music must be done within the bounds of the personal use statutes of applicable copyright laws.* ■



Copy Machine

Copy Machine allows you to make a copy of a Zip® disk using a single Zip drive. On Windows PCs, Copy Machine can also be used to copy files from one drive on your system to another (for example from the hard drive to your Zip drive). Note that Copy Machine cannot copy files that are in use. Copy Machine is available for Windows 95/98, Windows NT, and Windows 3.1.



Iomega Tools

Iomega Tools is a collection of disk and drive management utilities, including format, disk protection, drive startup options, and more. Under Windows 95/98 and NT 4.0, the Tools are available directly from the drive shortcut menus (just right mouse click any Zip® drive icon, then choose the tool you want to use). There are versions of Iomega Tools for Windows 95/98, Windows NT, and Windows 3.1.

*The IomegaWare™ software package shipped with your drive includes the programs described in this section. The programs that work on your system will vary depending on your operating system.



Drive Shortcuts

Create Drive Shortcuts puts a Zip® drive icon directly on your Desktop and in the “Windows\SendTo” and “My Documents” folders, making it easier to use your Zip drive. You can use these icons much like you would the Zip drive icon that is available in *My Computer* – double click the icon to open a window for your Zip disk or right mouse click the icon to access Iomega Tools. *Create Drive Shortcuts* runs automatically during setup to provide easy access to your Zip drive. If you want to remove the icons, you must use the *Remove Drive Shortcuts* icon in the IomegaWare folder (deleting the drive icons will not remove them). Drive shortcuts are available for Windows 95/98 and Windows NT.

For information on how to use IomegaWare™ software:

After the software is installed (see the instructions in the installation guide for your system), you can find information on using IomegaWare™ software by checking the help files as described below:

Windows 95/98 Users

Open **IomegaWare Quick Help** located in the IomegaWare™ folder on your Desktop. The Quick Help guide contains answers to frequently asked questions as well as troubleshooting and basic “how to” information. For additional help on any of the Iomega application programs, just open the application and click the Help button.

Users with Windows NT 4.0

Open **Iomega ToolsNT Help** from the IomegaWare™ folder on your Start Programs menu.

Users with Windows NT 3.51

Double click on the **Iomega ToolsNT Help** icon that is located in your IomegaWare program group.

Users with Windows 3.1 or Windows for Workgroups

Double click on the **IomegaWare Help** icon that is located in your IomegaWare program group.

Using Zip® Disks

Use only genuine 250MB* or 100MB* Zip® disks with your Zip drive. This section describes just some of the things you can do with Zip disks. The help files contained in your IomegaWare™ software package include additional information on using Zip disks.

Backing Up with Zip® Disks

It's important to always keep current backups of your valuable data – whether the primary data is stored on your hard drive or Zip® disks! And you can use Zip disks to back up both. The easiest way to back up your hard drive to Zip disks is to use the backup program included in your IomegaWare™ software package (**1-Step Backup/Restore** for Windows 95/98 and Windows NT).

If you want to back up important selected files and have them immediately available without having to run a restore procedure, you can use your system's standard procedures to copy files from your hard drive to your Zip® drive (for example, drag-and-drop files or folders using *My Computer* in Windows 95/98). For information on how to back up one Zip disk to another, see the next section.

■ **NOTE:** *The 1-Step Backup program is designed to back up data files and will not back up any of the operating system files on your hard drive or any files that are in use.* ■

Copying Zip® Disks

To make a copy of a Zip® disk, use **Copy Machine** – it can duplicate a Zip disk using a single Zip drive. To copy a disk with Copy Machine, double click the Copy Machine icon in your IomegaWare™ folder, insert the disk you want to copy, and follow the screen instructions. If you need information on how to set Copy Machine options, select Help from the Copy Machine menu bar.

■ **NOTE:** *Copy Machine cannot copy any files that are open or in use at the time the copy is made.* ■

■ **IMPORTANT!** *When copying Zip® disks on IBM-compatible PC systems, do NOT use the Microsoft CopyDisk utility that is available when you right mouse click on the Zip drive icon under Windows 95/98 or Windows NT. These utilities only work correctly with floppy drives.* ■

*250MB or 100MB capacity where 1MB = 1 million bytes. The capacity reported by your operating system may vary. Use 250MB Zip disks for maximum performance.

Installing Applications to Zip® Disks

On a PC, some applications and games will only install to, or run from, a fixed disk such as a hard drive. In order to install these programs to a Zip® disk, use the **Make Nonremovable** tool in your IomegaWare™ software package to make the Zip disk appear as a fixed disk to the system. After the software installation is complete, use **Make Removable** to restore disk removability. Note that you may need to use the **Make Nonremovable** tool whenever you run the program from your Zip disk.

■ **NOTE:** *The Zip® disk will not eject when you push the eject button if the Zip drive is in **Make Nonremovable** mode.* ■

Formatting Zip® Disks

Zip® disks are available pre-formatted for IBM-compatible PCs. You can format your Zip disks as needed using Format in Iomega Tools.

CAUTION *Formatting a disk erases all data on the disk. Do not format any disk that contains information you want to keep!* ■

Formatting Zip® Disks under Windows 95/98 or NT 4.0

1. Insert the disk you want to format into your Zip® drive.
2. Right mouse click on the Zip® drive icon on your Windows Desktop. (If you have removed the drive shortcut icons from your Desktop, open *My Computer* and right mouse click on the Zip drive icon.)
3. Select **Format** from the drive shortcut menu.
4. Choose the format type:
 - Use **Short Format** if you want to quickly erase all data on a disk so you can reuse it.
 - Use **Long Format with Surface Verify** if you want to change the format type (from Mac to PC), if you are formatting a disk where you have forgotten the password, or if you need to repair a disk that has developed read/write errors due to bad sectors.
5. Click **Start** to start formatting the Zip® disk.

Read/Write Protecting Zip® Disks

OmegaWare™ software includes a special read/write protect feature that allows you to:

- Write Protect a disk through software instead of with a mechanical write protect switch.
- Write Protect a disk and assign a password that must be used to remove the write protect.
- Read Protect a disk so that it cannot be read from, or written to, unless the user enters the password you assign.

Setting Zip® Disk Protection under Windows 95/98 and NT 4.0

1. Insert the disk you want to protect into your Zip drive.
2. Open *My Computer* and right mouse click on the Zip drive icon.
3. Select **Protect** from the drive shortcut menu.
4. Choose the protection option you want to use. Click the **Help** button if you need information on any of the options.

■ **NOTE:** *Although Zip disk protection options are set and removed using OmegaWare™ software, the actual protection mechanism is secured in the drive hardware. This means the disk protection cannot be bypassed using other software programs.* ■

Understanding IDE/ATAPI Connections

What is IDE?

IDE (Integrated Drive Electronics) is the built-in system a PC computer uses to connect drives to the computer. You may have also heard it called ATA (Advanced Technology Attachment)—they mean the same thing.

How IDE Works

There are usually two places on the motherboard for the IDE cables to connect. These are the primary and secondary IDE channel connections. The hard drive usually uses the primary connection. The IDE channel connections are usually located next to each other either end-to-end or one above the other. They are also generally labeled on the motherboard as “pri IDE” and “sec IDE” or something similar. If you are unsure of where the IDE channels for your computer are located, refer to your computer’s documentation.

The IDE channels can support a maximum of two drives each. If there are two drives connected to the IDE interface cable, one drive must be configured as a master and the other as a slave. If only one drive is attached to the cable, it is configured as a master.

What is ATAPI?

IDE (ATA) was originally designed for hard disks only, not removable devices such as Zip® drives, CD drives and tape drives. ATAPI, which stands for Advanced Technology Attachment Packet Interface, is designed to bridge this gap and support removable drives. ATAPI devices use your IDE channel to communicate with the computer.

Jumper Settings

The jumper is the small plastic piece that surrounds two pins and can be removed and placed in different locations as needed. There are different jumper configurations that can be used with ATAPI devices such as your Zip® drive. There are also jumper blocks located on the back of your CD drive and hard drive. If you need to change the settings on your CD drive, refer to the table on the next page on the CD drive or in its documentation. This diagram shows the possibilities for the Zip Internal drive.

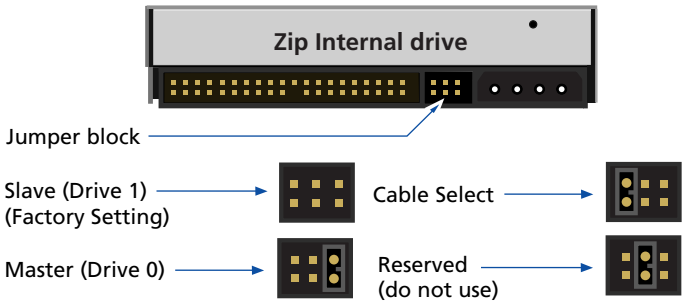

Slave (Drive 1)

Use this setting if you're connecting the Zip® Internal drive on the same cable as your CD drive or another ATAPI device that is configured as the master.

Master (Drive 0)

Use this setting if you're connecting the Zip® Internal drive as the only device on the secondary IDE channel or when installing to an IDE add-on card. Use the jumper provided when configuring the drive to the "Master" setting.

Cable Select

Use this jumper setting if your computer features "Cable Select." On a Cable Select system, the master/slave configuration is automatically determined by the system. Contact the computer manufacturer if you need additional information. Use the jumper provided when configuring the drive to the "Cable Select" setting.

Possible System IDE/ATAPI Configurations

Your computer may be configured in one of the following ways. If you need to change the jumper settings for your CD drive, check its documentation to see how to configure it as master or slave as needed.

(Recommended)

	Primary IDE Channel	Secondary IDE Channel
Master Device	Hard Drive	CD drive
Slave Device		Zip ATAPI Drive

(Alternative)

	Primary IDE Channel	Secondary IDE Channel
Master Device	Hard Drive	Zip ATAPI Drive
Slave Device	CD drive	

(Alternative)

	Primary IDE Channel	Secondary IDE Channel
Master Device	Hard Drive	Zip ATAPI Drive
Slave Device		CD drive

BIOS/CMOS Support

BIOS support for the Zip® Internal drive should be disabled in the CMOS Setup. If your system includes autodetection, it should be turned off for the Zip Internal drive.

Troubleshooting

If you encounter a problem while installing or using your Zip® drive, check this section for help.

CAUTION *To avoid damage to your computer, disconnect all electrical connections before connecting or disconnecting cables.* ■

The green activity light on the Zip® drive does not turn on.

- (a) Make sure the computer is receiving power.
- (b) Make sure the power cable connection to the Zip® Internal drive is secure.
- (c) Make sure there is a disk in the drive.

The Zip® drive is not assigned a drive letter, or the Iomega software cannot find the Zip® drive.

- (a) Make sure PIN 1 is properly connected on all IDE interface connections. The stripe on the interface cable should align with PIN 1 on each connection. If the cable does not have a keyed connector, make sure the connector has not shifted by a pair of pins.
- (b) Make sure the Zip® Internal drive IDE channel connections and the jumper settings are correct. Refer to the Hardware Installation Guide pages 4 - 22 for details.
- (c) If there is another drive on the same IDE channel, make sure it is also properly configured. Refer to the documentation that accompanied the other IDE drive for configuration information (often this information is on the drive case). If you cannot locate the documentation, contact the manufacturer of the drive.
- (d) Make sure the software drivers for the Zip® Internal drive are correctly installed on the computer system. The necessary drivers are included with the IomegaWare™ software package. Carefully follow the installation instructions given for the computer's operating system, starting on page 23 of the Installation Guide section.
- (e) Make sure BIOS support for the Zip® Internal drive is disabled in the computer's CMOS setup. Note that this may require turning off autodetection for the Zip Internal drive. Refer to the Owner's Manual for the computer if you need instructions on getting into the CMOS setup and disabling autodetection.

If you are unable to disable BIOS support for the Zip® drive in the CMOS setup and the Zip Internal drive does not appear on the system, the computer may have an incompatible BIOS that does not correctly understand removable internal drives. You may be able to solve the problem by obtaining an updated BIOS from the computer manufacturer. If an updated BIOS is not available, it may be possible to install the Zip Internal drive using an add-on IDE card.

- (f) If the computer's operating system is Windows 95/98, make sure the system is running in 32-bit mode (Protected mode). To check whether the system is running in 32-bit mode, right mouse click on *My Computer* and select "Properties." Click the "Performance" tab and check that "File System" and "Virtual Memory" are listed as 32-bit. If the mode is 16-bit, refer to the Windows 95/98 documentation for instructions on improving the system performance to 32-bit.
- (g) Some IDE hard drives do not work properly unless they are in a certain position on the IDE cable. You may need to reverse the position of the master drive, such as a CD drive, and the Zip® Internal (slave) drive on the cable for the drives to work properly.
- (h) If the computer still does not recognize the Zip® Internal drive, it may be that the existing IDE master drive does not allow access to a slave drive on the same cable. If the Zip Internal drive is currently on the primary IDE channel, try installing it on the secondary IDE channel or rearrange devices to make the Zip drive a master drive.

Computer does not recognize a slave drive connected to the same IDE connection with a Zip® Internal master drive.

- (a) Make sure PIN 1 is properly connected on all IDE interface connections. The stripe on the interface cable should align with PIN 1 on each connection. If the cable does not have a keyed connector, make sure the connector is not shifted by a pair of pins.
- (b) Make sure the slave drive is correctly jumpered as a slave. Refer to the documentation that accompanied the slave drive for configuration information (often this information is on the drive case). If you cannot locate the documentation, contact the manufacturer of the drive.
- (c) Some IDE hard drives do not work properly unless they are in a certain position on the IDE cable. You may need to reverse the position of the slave drive and the Zip internal (master) drive on the cable for the slave drive to work properly.

Computer fails to boot correctly or hangs while booting after the Zip® Internal drive is installed.

Make sure BIOS support for the Zip® Internal drive is disabled in the computer's CMOS setup. Note that this may require turning off autodetection for the Zip Internal drive. Refer to the Owner's Manual for the computer if you need instructions on getting into the CMOS setup and disabling autodetection.

If you are unable to disable BIOS support for the Zip® drive in the CMOS setup and the computer hangs during boot-up, the computer may have an incompatible BIOS that does not correctly understand removable internal drives. You may be able to solve the problem by obtaining an updated BIOS from the computer manufacturer. If an updated BIOS is not available, it may be possible to install the Zip Internal drive using an add-on IDE card.

Computer will not boot under Windows NT unless a disk is present in the Zip® Internal drive.

This happens if Windows NT has set the Zip® Internal drive as the location for the system page file. To eliminate the problem under version 4.0, open the Control Panel and double click on the "System" icon. Click the "Performance" tab and change the location of the system page file. Note that you may not be able to use the default hard drive as the location for the system page file if it does not have sufficient space available. (This may be why Windows NT set the Zip drive as the system page file location.)

Data transfer problems or drive operation is erratic.

Make sure the Zip® Internal drive is electrically grounded. If the drive bay mounting screws do not make contact with a direct metallic path to the Zip drive chassis (for example, if you are using a plastic carrier to mount the drive in a 5 1/4" bay), then you need to provide a grounding strap. The grounding strap should be a wire from the ground lug on the right side of the drive by the power connector to a solid, metal connection on the computer chassis.

Installing the Zip® drive changes other drive letters.

Drive letter assignments are controlled by the operating system – in order to change a drive letter assignment, you must work with the procedures required by your computer's operating system. Use the instructions on page 41 to change the drive letter.

You want to change the drive letter assigned to the Zip® drive.

Windows 95/98 Users:

If your computer is running Windows 95/98, you can change drive letters as desired for any of your removable drives (including your Zip® drive and CD drive) by running the Guest program (guest9x.exe). Use the instructions below:

- (a) Open the IomegaWare™ folder on your Desktop.
- (b) Double click on the Guest icon.
- (c) Guest will display the current drive letter assignments on your system.
- (d) To change the drive letter for any removable drive, click the drop-down arrow next to the current drive letter and select the drive letter you want to use.



Windows 3.1 Users:

If your computer is using Windows 3.1, refer to the information in the electronic manual on the IomegaWare CD. To access the manual, insert the IomegaWare CD into the computer's CD drive and double click on the file **manual.exe** in the Windows File Manager. Follow the instructions on the first panel of the manual to jump directly to the section on DOS drive letter assignments (Section 4.1).

Windows NT Users:

Changing drive letter assignments under Windows NT is a fairly technical process. If you want information on doing this, refer to the MS Knowledgebase on Microsoft's web page at:

<http://www.microsoft.com>

If you cannot readily locate the MS Knowledgebase, select Microsoft's support option and enter a keyword search for "cannot change drive letter of removable drive."

You can't change the drive letter assigned to your Zip® drive.

Make sure BIOS support for the Zip® Internal drive is disabled in the computer's CMOS setup. This may require turning off autodetection for the Zip Internal drive. Refer to the Owner's Manual for the computer if you need instructions on getting into the CMOS setup and disabling autodetection.

Zip® disk won't eject using Windows NT

If a disk does not eject from the Zip® Internal drive, one of the following suggestions should solve the problem:

- (a) Close any windows listing the disk contents (such as *My Computer* or *Windows Explorer*).
- (b) The Iomega Zip ATAPI driver may not have loaded correctly. Try reinstalling the driver following the instructions starting on page 23 of this manual.
- (c) If the disk still does not eject immediately, it may be due to the way Windows NT handles disk caching. Eventually, NT will allow the disk to eject.

Hard drive does not appear as an option in Copy Machine when using Windows 3.1.

When using Copy Machine in Windows 3.1 or Windows for Workgroups 3.11, turn off 32-bit disk and/or file access. (This option is available when changing virtual memory options under *386 Enhanced* in the Windows Control Panel). If 32-bit access is not turned off, your hard drive will not appear for selection in the Copy Machine window.

You want to use Windows 95/98 DOS mode with your Zip® drive.

■ **NOTE:** *This section describes how to switch in and out of the MS-DOS mode which is a start option for Windows 95/98. It does not apply to the DOS box (or window) that opens when you double click the **MS-DOS Prompt** icon within Windows 95/98. Use of the DOS box with the Zip® drive works the same as it does with any other drive under Windows 95/98.* ■

In order for the Zip® drive to operate properly in Windows 95/98 DOS mode, you must perform a clean reboot when switching to or from DOS mode. Do not use the option from the Windows 95/98 Shut Down menu that reads: "Restart the computer in MS-DOS mode." This option does not fully support the Zip drive.

To switch to DOS mode:

- (1) Restart the computer and press F8 just before the full-color Windows logo screen loads. (If you are using Windows 95, look for the text line "Starting Windows 95" to appear on the screen. If you are using Windows 98, watch for a black screen with a blinking cursor.)
- (2) When the menu appears, select "Command Prompt Only."
- (3) After the system boots into DOS mode, run **guest.exe** from the directory containing your IomegaWare™ software. If you have used the default directory for a new software installation, the command line is:

c:\progra~1\iomega\tools\guest.exe

This procedure will provide access to any Iomega drives on the system. To return to the Windows 95/98 graphical interface again, restart the computer.

■ **IMPORTANT!** *Do NOT type "WIN" at the DOS prompt after running GUEST.EXE as this will cause duplicate drive letters.* ■

How to Get Help

Iomega's goal is to provide state-of-the-art support for its customers. Over time, our support options and pricing policies may change in light of evolving technology and global changes across the computer industry. This section of the manual contains information on the support options available at the time this manual was prepared. For up-to-date support information, contact Iomega's Home Page on the World Wide Web or call our automated FAX-back help system at 1-801-778-5763.

Iomega's Home Page: <http://www.iomega.com>

If you have access to the Internet, Iomega's home page offers advanced problem-solving support readily available 24 hours a day. Here's just some of what you can do from our home page:

Download the latest IomegaWare™ software – The software that shipped with your drive may be updated over time. Choose **Software Download** from the Iomega Home Page to check for the most up-to-date IomegaWare™ software.

Diagnose and solve problems on-line – Use your Web browser to access individualized troubleshooting for all Iomega products. With a little information from you, the interactive troubleshooting system diagnoses your problem and guides you through a solution. It's like having a personal support technician available 24 hours a day!

Locate Iomega manuals – You can access an electronic copy of the manual for any Iomega product in PDF format. All you need to view and print the PDF file you select is the Acrobat Reader. If you don't already have the Acrobat Reader installed on your system, you can download it from Adobe's Web site: <http://www.adobe.com>.

Access on-line help pages – You can find help pages with answers to common questions (FAQs), troubleshooting or basic "how to" information. The help pages are in HTML format and can be viewed and browsed directly within your Web browser.

Automated Voice Technical Support: 1-800-879-7660*

This free, 24 hour support option allows you to use a touch-tone phone to quickly and easily access pre-recorded solutions to common problems. Just dial 1-800-879-7660* and the automated voice technical support system will guide you through a series of questions to an easy-to-follow solution.

*1-800-879-7660 is available in the U.S. and Canada only.

Automated FAX-back Help: (801) 778-5763 (U.S. & Canada)

Our FAX-back automated help system allows you to use any touch-tone phone to instantly retrieve detailed support information to your FAX machine. When you call our FAX-back help number, you can order a catalog listing the FAX-back documents available for your Iomega product, or any document listed in the catalog. Just follow the voice instructions to order what you need.

One-on-One Iomega Technical Support

If you don't have access to the Internet or a FAX machine and you have a problem you just can't resolve using our automated voice technical support system or the troubleshooting information in the manual, you can call One-on-One technical support for help.

Before calling Iomega for technical support, turn on your computer and call from a phone at or near your computer. You may be asked to type commands at the keyboard or relay information about the system.

If your Zip® product is under warranty, One-on-One technical support is currently provided free of charge (i) during the warranty period for a consecutive 30-day period beginning with the first call, and (ii) for those calls during the warranty period in which your product is determined to be defective. Other calls are charged at the rate of \$14.99 per incident. You can call 1-888-4-IOMEGA* (1-888-446-6342), toll-free, to charge the support cost to your credit card (VISA, MasterCard, American Express, or Discover), or you can call 1-900-988-4318** to put the support cost on your phone bill. Your credit card will not be charged if your Zip product is still under warranty and (i) if your call is made within thirty days from your first call for technical support, or (ii) if your Zip product is determined to be defective. Technical support fees are subject to change without notice.

Iomega's highly trained technical support associates are ready to take your call Monday through Friday from 6 a.m. to 9 p.m. and Saturday from 7 a.m. to 2 p.m. (Mountain Time). Technical support hours are subject to change without notice.

*1-888-4-IOMEGA is available in the U.S. and Canada.

**1-900-988-4318 is a toll call of \$14.99. This number is available only in the U.S.

Continued on next page ...

Return or Repair

For information on returning your Zip® drive or other Iomega product for warranty service (or repair after the warranty period), please call the Iomega Customer Satisfaction Hotline at 1-888-4-IOMEGA (1-888-446-6342). Because many returns are found to be due to a technical problem rather than a defective product, you may want to check with Iomega Technical Support before returning your drive – our trained support personnel can often resolve the problem over the phone. If you choose to contact Technical Support, you will not be charged the standard support fee for the call if your Iomega product is still under warranty and is determined to be defective.

Limited Warranty Information

Your Zip® drive has a one-year limited warranty from the date of purchase. For complete warranty information, refer to the warranty card included with your drive. If you have a question about the limited warranty on your Zip drive or other Iomega product, please call 1-888-4-IOMEGA (1-888-446-6342) and choose the option for warranty information. If you choose to contact Technical Support, the standard support fee may apply.

Product Information

Call 1-800-MY-STUFF (1-800-697-8833) for information on new Iomega products, promotions, and rebates. You can also purchase Iomega products over the phone using your credit card (VISA, MasterCard, American Express, or Discover). Simply select the option of interest to you. See the Iomega web site for detailed product specifications.

International Support Numbers

For information on international customer support options and phone numbers, contact the Iomega Web site at <http://www.iomega.com>.

Regulatory Information

Product Name: Iomega Zip® Internal ATAPI 250MB drive

Model Number: Z250ATAPI

FCC (United States)

The computer equipment described in this guide generates and uses radio frequency (RF) energy. If the equipment is not installed and operated in strict accordance with the manufacturer's instructions, interference to radio and television reception may result.

■ **Interference** *This equipment complies with Part 15 of the FCC Rules and its operation is subject to the following conditions; (1) the equipment may not cause harmful interference, and (2) the equipment must accept any interference received, including interference that may cause undesired operation.* ■

Part 15, Class B, of the FCC Rules, is designed to provide reasonable protection against radio and television interference in a residential installation. Although the equipment has been tested and found to comply with allowed RF emission limits, as specified in the above cited Rules, there is no guarantee that interference will not occur in a particular situation. Interference can be determined by turning the equipment off and on while monitoring radio or television reception. The user may be able to eliminate any interference by implementing one or more of the following measures:

- Reorient the affected device and or its receiving antenna.
- Increase the distance between the affected device and the computer equipment
- Plug the computer and its peripherals into a different branch circuit from that used by the affected device.

WARNING *Changes or modification to the electronics or enclosure of this product must be expressly approved by Iomega; otherwise, the user's authority to operate the equipment may be voided by the FCC.* ■

Canadian Verification

This Class B digital apparatus meets all requirements of the Canadian Interference-Causing Equipment Regulations (ICES-003, Class B).

CE (European Community)

The Zip Internal ATAPI 250MB Zip drive conforms to the following European Directive(s) and Standard(s): Application of Council Directives: 73/23/EEC, 89/336/EEC. Standards to which Conformity is declared: EN60950, EN55022, EN50082-1. Importer's Name: Iomega Netherlands branch of Iomega International, S.A. Type of Equipment: Internal Disk Drive.

Manufacturer/Responsible Party

Iomega Corporation
1821 West Iomega Way
Roy, UT 84067 U.S.A.
801-778-1000

Visit our web site!

<http://www.iomega.com>

- Free software updates* and cool free software
- Online Customer Support
- Purchase Iomega products at BuyIt Online
- Product information and specifications
- Customer solutions for educators, businesses, and home
- Special promotions and contests
- News releases and company information
- The latest and greatest from Iomega!

* The software that shipped with your drive may be updated over time. Choose Software Download from the Iomega Home Page to check for the most up-to-date software versions. Check back often for free updates and special software promotions.



Copyright © 1999 Iomega Corporation. The following trademarks of Iomega are registered in the U.S. Patent and Trademarks Office and in other countries: the graphic "hand" and "swirl" designs, Iomega, the stylized "i" logo, Zip and the "1 & foot print" icon. Some other marks of Iomega which may be registered in some countries are the following: the graphic "eye" design, IomegaWare, Zip 100, Zip 250, the Zip 100 block, and the Zip 250 brand block. Certain other product names, brand names and company names mentioned in this material may be trademarks or designations of their respective owners.

03798300 2/17/99 r12